

High speed of 100 μ s

Ultra high-speed & stable measurement for a variety of measurement objects

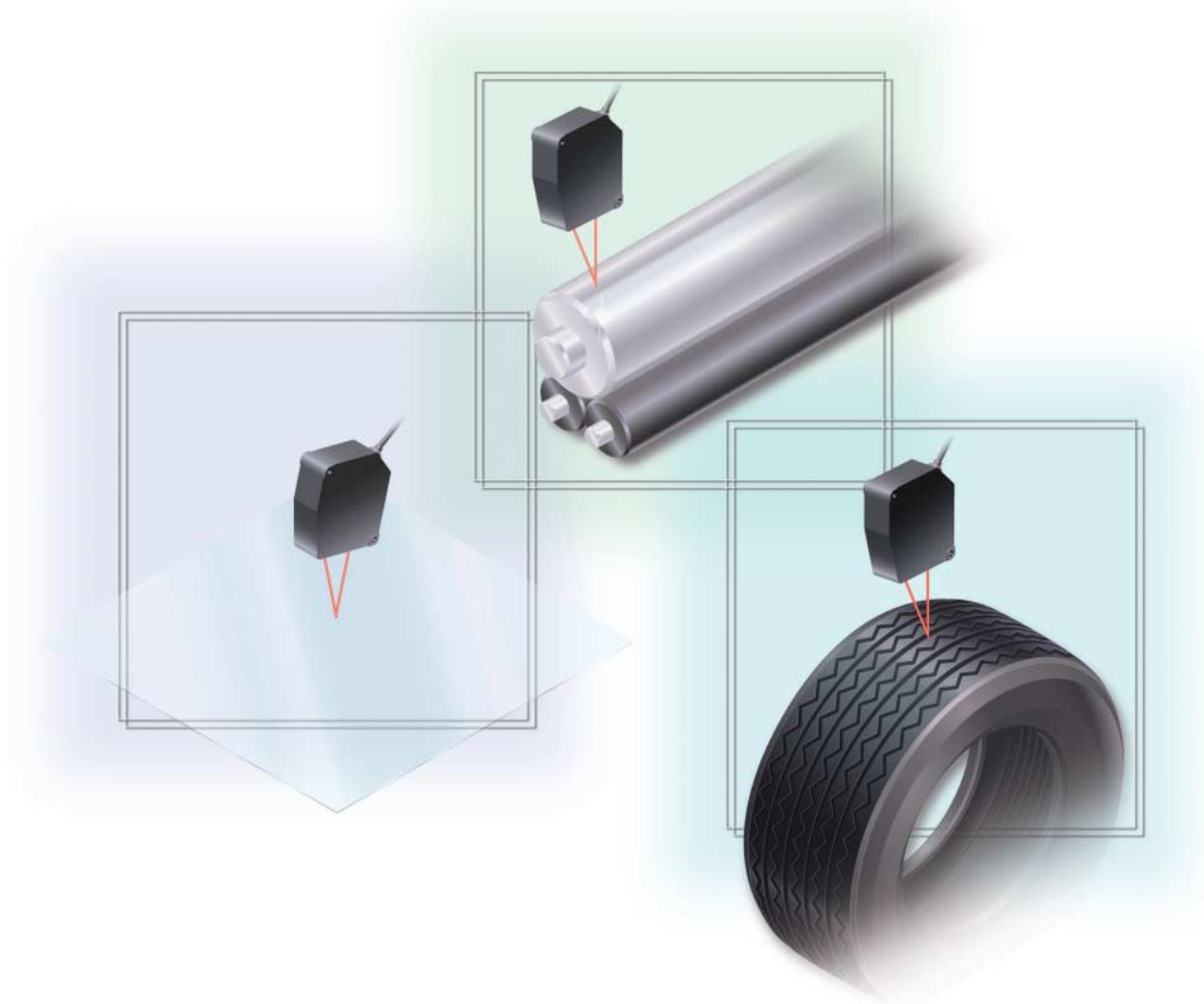

Stable high-speed measurement is now available for a variety of measurement objects, through the combination of SUNX's unique 100 μ s high-speed sampling optical system together with a linear image sensor.

Black rubber with a low reflected light intensity, objects with uneven surfaces, specular objects, such as wafers, and transparent objects, such as the glass used in liquid crystal displays.

SUNX has now integrated all the technologies required to enable stable and consistent measurement of these objects, which were previously considered as difficult objects to be measured.

Through the fusion of our unique newly developed optical system, linear image sensor method and high-speed sampling technology, a wide variety of objects can now be stably measured with great precision at ultra high speeds.

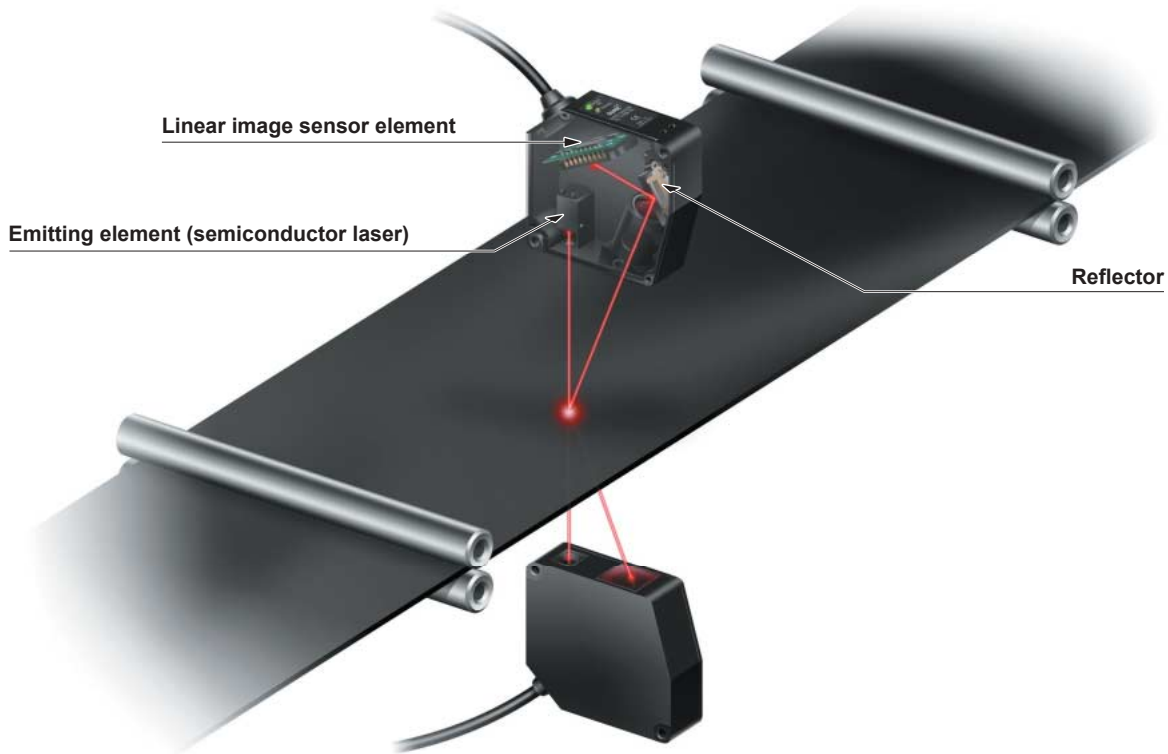

100 μ s, fast sampling rate

Ultra high-speed sampling of 100 μ s has now been achieved, thus enabling ultra high-speed measurement of rotating, vibrating and moving objects.

High precision measurement is now possible, unaffected by the surface condition of the detected object

All deficiencies inherent in the conventional PSD sensing method have now been solved. Whereas the PSD method measures position information from the center of gravity of the total light quantity distribution of the light spots connected along each light element, the linear image sensor method measures the peak position values of the light spots themselves. This advancement now makes high-precision measurement possible, regardless of the surface condition of the object whether for metal hairline surface cracks or for non-reflective black rubber.

Resolution of 1 μ m 0.039 mil, linearity of ± 0.1 % F.S.

Now available with ultra-precise 1 μ m 0.039 mil resolution measurement capability (HL-C105□) and a linearity of ± 0.1 % F.S. (for all models).

FDA regulations conforming types are available

FDA regulations conforming types, most suitable for equipment used in the USA, are available.

Change in measurement data due to color difference (White Ceramic / Black Rubber)

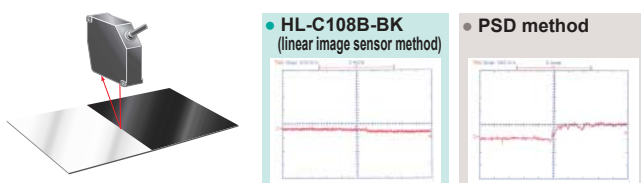

Principle For detection of a V-shaped groove

<Linear image sensor method>

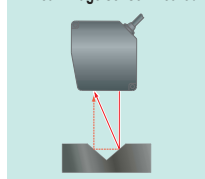

As the sensor measures the peak position of the light spot, it is not affected by secondary reflected light, resulting in no error.

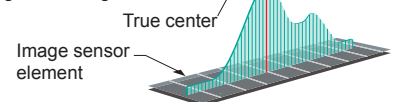

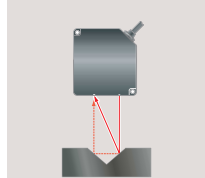

<PSD method>

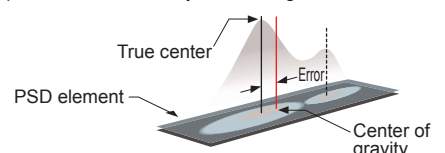

As the sensor measures the center of gravity of the entire light quantity distribution of the beam spot as position information, errors occur due to the presence of secondary reflected light.

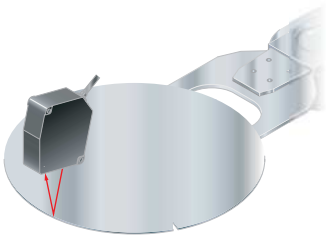
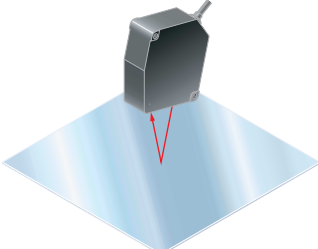
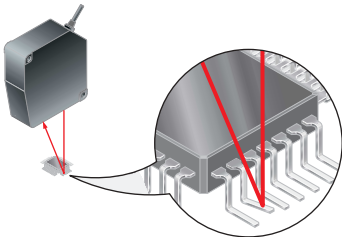
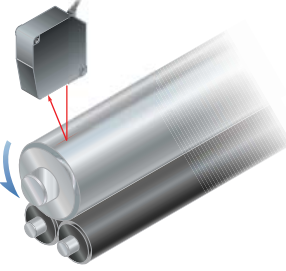
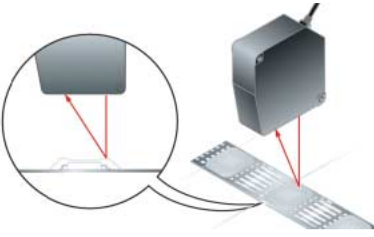
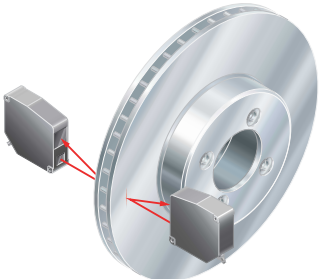

APPLICATIONS

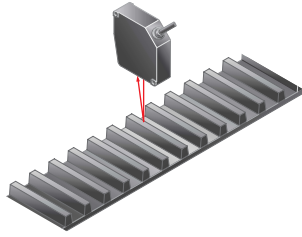
	Positioning wafer	Measuring glass substrate thickness
		
Checking IC pins	Measuring the eccentricity of metal shaft	Detecting the presence of a resin coating
		
Measuring disk brake thickness	Inspecting tire form	Measuring gap spacing in rubber belt material
		

5 types to suit your measurement objects

5 types and 9 models are available depending on the measurement object and distance. In addition, a wide measuring range is possible to facilitate various measurement objects and installation conditions.

For diffuse reflective objects, such as plastic, rubber and metal objects

Wide range type
HL-C135C-BK10
Measuring range: 350 mm ±200 mm 13.780 in ±7.874 in

Diffuse reflective type
HL-C108B-BK
HL-C108F-BK
Measuring range: 85 mm ±20 mm 3.346 in ±0.787 in

Diffuse reflective type
HL-C105B-BK
HL-C105F-BK
Measuring range: 50 mm ±5 mm 1.969 in ±0.197 in

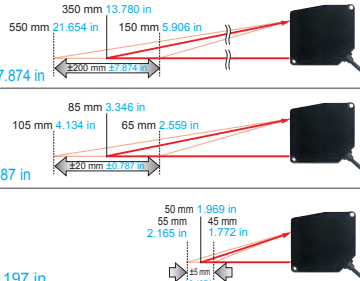

For specular reflective objects, such as specular and transparent objects

Specular reflective type
HL-C108B
HL-C108F
Measuring range: 81.4 mm ±16 mm 3.205 in ±0.630 in

Specular reflective type
HL-C105B
HL-C105F
Measuring range: 46 mm ±4 mm 1.811 in ±0.157 in

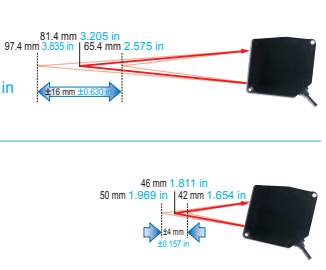

The long and wide range

• Measures wide changes over long ranges

The long and wide range capabilities over 350 mm ±200 mm 13.780 in ±7.874 in allow large changes to be measured. Even if the object position changes, there is no need to change the sensor head settings or position.

• High speed and high precision even over long and wide ranges with an ultra-small head

High-speed and high-precision performance has been achieved in an ultra-small head of W26.6 × H82 × D87 mm W1.047 × H3.228 × D3.425 in with a high-speed sampling of 100 μs at a resolution of 10 μm 0.394 mil, and a linearity of ±0.1 % F.S.

Sensor head HL-C135C-BK10 Controller HL-C1C-M-WL



Compact console with touch panel and thin, ultra-compact controller integrate high functionality to provide a comfortable operating environment!

The compact design significantly reduces the installation space required for the controller and console. The controller allows multiple sensor head connections, reducing costs and saving space, yet incorporating a great variety of convenient functions. The HL-C1 series integrates outstanding measurement performance and signal processing technology into a truly comfortable operating environment.

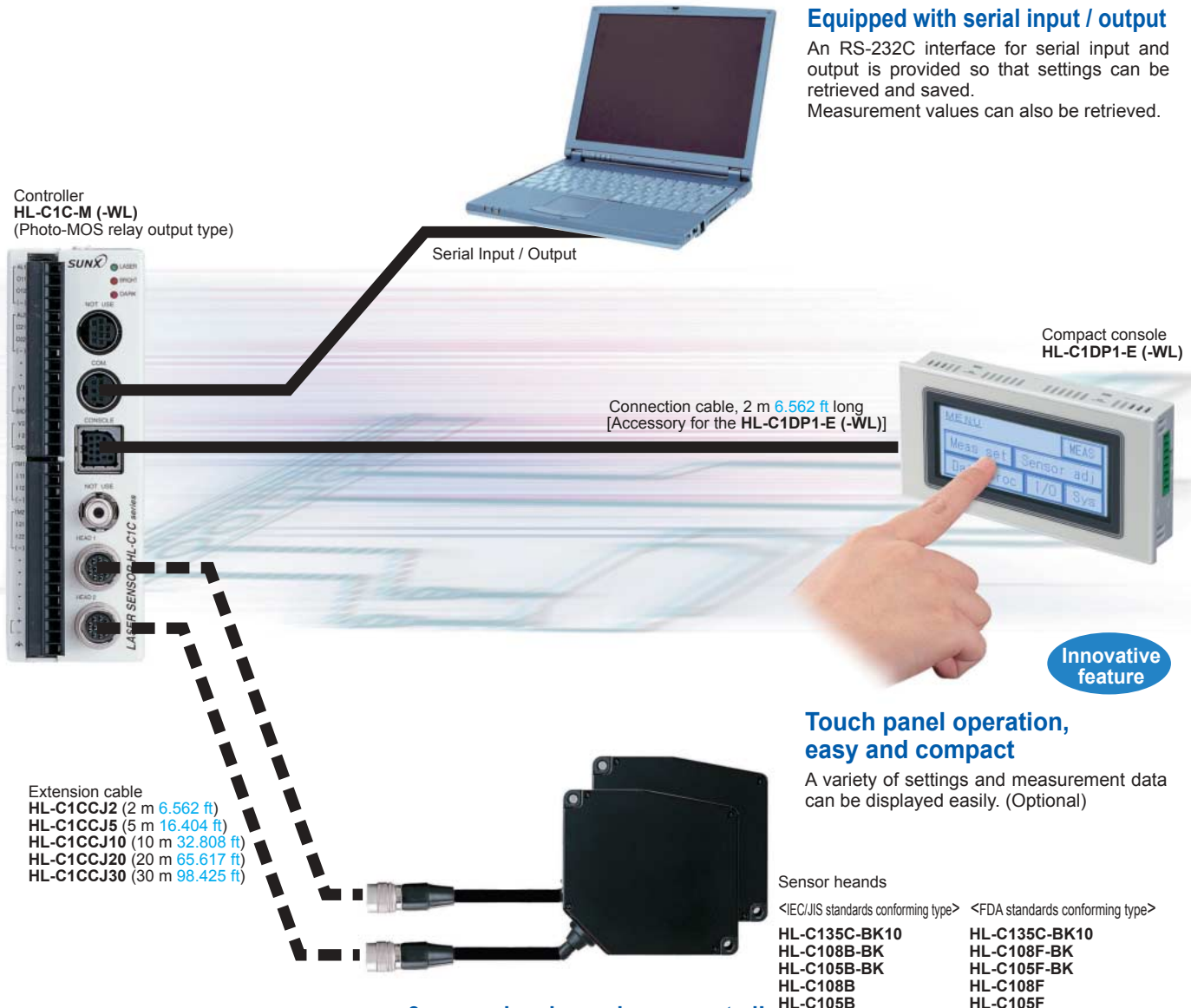

Calculations can be performed when 2 sensor heads are used

The built-in calculation function allows measurement of gap and thicknesses without requiring a digital panel controller, thus saving further on costs and space.

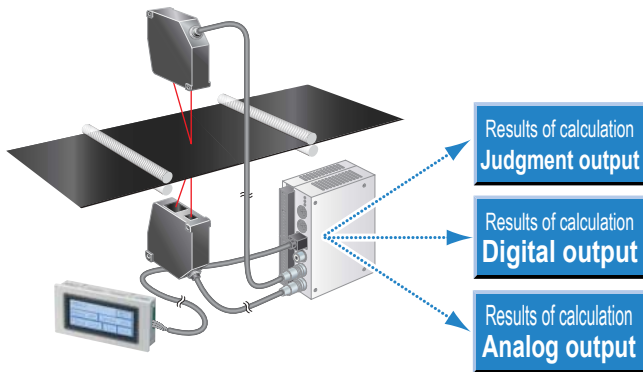

Enhanced functionality

The HL-C1 series incorporates a great number of useful functions, including hold function, calculation function, filter function and hysteresis-setting function, which facilitate convenient usage in a variety of diverse applications.

Low-pass / High-pass Filter Functions

<Low-pass filter function>

For example, if the surface condition of a metal object causes noise that interferes with accurate measurement, the use of the low-pass filter function will reduce the effects of noise and allow for stable measurement of displacement.

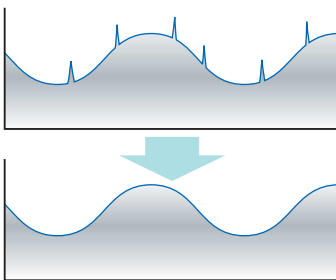

Measuring the eccentricity of a metal shaft

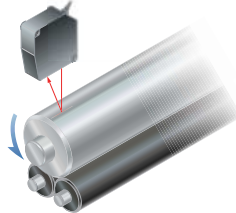

<High-pass filter function>

When measuring seams and gaps in objects that undergo large displacement changes due to vibration or tilting, such as measuring the eccentricity of a rotating object, this function will minimize the effects of these undulations and enable accurate measurement of seams and gaps.

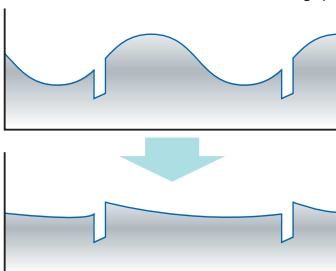

Detecting the seams of a metal drum

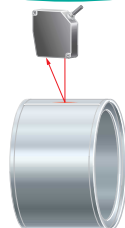

Waterproof sensor head construction, compliant with IP67 rated protection

The HL-C1 series can withstand water splashes.



Note: Accurate measurement cannot be performed if water is present on the sensing window of the sensor head itself.

Compact controller and front connection reduce setup space

The ultra-compact controller HL-C1C-M with dimensions of W40 × H120 × D74 mm **W1.575 × H4.724 × D2.913 in** requires much less space for installation. Tight installation is also possible. Furthermore, the cables can be connected directly or to a removable terminal block, so that all connections come from the same direction in order to further save space.



Analog Output Switching Function During Alarm Output

During measurement, if the unit becomes incapable of performing measurements due to excessive or insufficient incident light intensity (during alarm output), this function allows the analog output to be switched to either hold the data obtained just previously, or to output a fixed value. If the fixed value is selected, one of two options can be chosen for the analog output, during alarm output: the output of the maximum value (voltage output: +10.9 V, current output: 29.5 mA) or the output of the minimum value (voltage output: -10.9 V, current output: 0 mA).

Maximum analog output value

The analog output can be used to confirm whether or not the unit is capable of performing measurements.

Performing measurements on an object that contains a hole

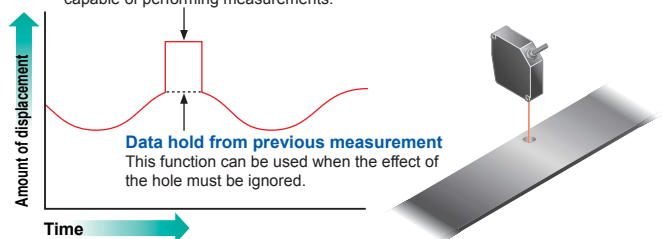

Hold Functions









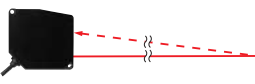

The HL-C1 series incorporates 4 hold modes.

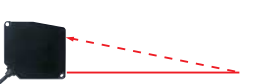
NORM (no hold)	This mode outputs the amount of displacement from the measurement center distance in real time. This mode is utilized for general-purpose operation.
P-P	This mode holds the output at the difference between the maximum and minimum measured values. This mode is utilized for vibration or eccentricity measurements.
PEAK	This mode holds the output at the maximum measured value.
VALLEY	This mode holds the output at the minimum measured value.

Easy maintenance with sensor head compatibility

Maintainability has been significantly improved. Compatibility has been achieved through the incorporation of correction data into the sensor heads themselves. This sensor series no longer needs the amount of maintenance usually required for conventional displacement sensors of its class.



Sensor heads

Type	Appearance	Measurement center distance	Resolution (Note 1, 2)	Beam diameter	Model No.	Applicable controller	Applicable console	Conforming standards / regulations
Diffuse reflective type	Wide range 	 350 mm 13.780 in (Measuring range ± 200 mm ± 7.874 in)	10 μm 0.394 mil	400 × 200 μm 15.748 × 7.874 mil approx.	HL-C135C-BK10	HL-C1C-M-WL	HL-C1DP1-E-WL	IEC / JIS / FDA
	General purpose 	 85 mm 3.346 in (Measuring range ± 20 mm ± 0.787 in)	2 μm 0.079 mil	100 × 140 μm 3.937 × 5.512 mil approx.	HL-C108B-BK HL-C108F-BK	HL-C1C-M	HL-C1DP1-E	IEC / JIS FDA / IEC / JIS
	High precision 	 50 mm 1.969 in (Measuring range ± 5 mm ± 0.197 in)	1 μm 0.039 mil	70 × 120 μm 2.756 × 4.724 mil approx.	HL-C105B-BK HL-C105F-BK			IEC / JIS FDA / IEC / JIS
Specular reflective type	General purpose 	 81.4 mm 3.205 in (Measuring range ± 16 mm ± 0.630 in)	2 μm 0.079 mil	100 × 140 μm 3.937 × 5.512 mil approx.	HL-C108B HL-C108F			HL-C1C-M
	High precision 	 46 mm 1.811 in (Measuring range ± 4 mm ± 0.157 in)	1 μm 0.039 mil	70 × 120 μm 2.756 × 4.724 mil approx.	HL-C105B HL-C105F	IEC / JIS FDA / IEC / JIS		

Notes: 1) These values were obtained by converting P-P values into a distance. The P-P values indicate the distribution of measured values throughout the measurement center distance.

2) These values were obtained with an average number of samples: 256, when using an object made of our company's standard white ceramic for measurement (an aluminum vapor deposition surface reflection mirror was used with specular reflective types).

Controllers

Type	Appearance	Model No.	Judgment outputs
Standard		HL-C1C-M	Photo-MOS relay
For HL-C135C-BK10		HL-C1C-M-WL	

Compact consoles

Type	Appearance	Model No.
Standard		HL-C1DP1-E
For HL-C1C-M-WL		HL-C1DP1-E-WL

ORDER GUIDE

Sensor head extension cable

Appearance	Model No.	Description	
	HL-C1CCJ2	Length: 2 m 6.562 ft , Net weight: 160 g approx.	Cabtyre cable with connector on both ends Cable outer diameter: \varnothing 7 mm \varnothing0.276 in Connector outer diameter: \varnothing 14.7 mm \varnothing0.579 in max.
	HL-C1CCJ5	Length: 5 m 16.404 ft , Net weight: 350 g approx.	
	HL-C1CCJ10	Length: 10 m 32.808 ft , Net weight: 700 g approx.	
	HL-C1CCJ20	Length: 20 m 65.617 ft , Net weight: 1,400 g approx.	
	HL-C1CCJ30	Length: 30 m 98.425 ft , Net weight: 2,000 g approx.	

Intelligent monitor

Appearance	Model No.	Description
	HL-C1AiM	Enables the waveform display of each measurement condition setting and of measurement values as well as monitoring of measurement data and received light intensity data. 1pc. of COM port connection cable manufactured by Matsushita Electric Works, Ltd. is attached.

SPECIFICATIONS

Sensor heads

Item	Type	Diffuse reflective type		
		Wide range	General purpose	High precision
Model No.	IEC / JIS standards conforming type FDA regulations conforming type	HL-C135C-BK10	HL-C108B-BK HL-C108F-BK	HL-C105B-BK HL-C105F-BK
Measurement center distance		350 mm 13.780 in	85 mm 3.346 in	50 mm 1.969 in
Measuring range		\pm 200 mm \pm7.874 in	\pm 20 mm \pm0.787 in	\pm 5 mm \pm0.197 in
Resolution (Note 2, 3)		10 μ m 0.394 mil	2 μ m 0.079 mil	1 μ m 0.039 mil
Linearity (Note 4)		\pm 0.1 % F.S.		
Temperature characteristics		0.02 % F.S./ $^{\circ}$ C		
Laser emission indicator		Green LED (lights up during laser emission or immediately before laser emission)		
Measuring range indicator		Yellow LED (blinks within the measuring range and lights up when near the measurement center distance)		
Environmental resistance	Pollution degree	3 (Industrial environment)		
	Protection	IP67 (IEC) (excluding the connector)		
	Ambient temperature	0 to +45 $^{\circ}$ C +32 to +113 $^{\circ}$F (No dew condensation), Storage: -20 to +70 $^{\circ}$ C -4 to +158 $^{\circ}$F		
	Ambient humidity	35 to 85 % RH, Storage: 35 to 85 % RH		
	Ambient illuminance	Incandescent light: 3,000 lx at the light-receiving face		
	Voltage withstandability	500 V AC for one min. between the exclusive controller power input part and the sensor head enclosure		
	Insulation resistance	20 M Ω , or more, with 500 V DC megger between the exclusive controller power input part and the sensor head enclosure		
	Vibration resistance	10 to 55 Hz (period: 1 min.) frequency, 1.5 mm 0.059 in amplitude in X,Y and Z directions for two hours each		
Shock resistance	196 m/s ² acceleration (20 G approx.) in X,Y and Z directions for three times each			
Emitting element		Red semiconductor laser, Class 3B (Class III b for FDA regulations) (Max. output: 10 mW, Peak emission wavelength: 658 nm 0.026 mil)	Red semiconductor laser, Class 2 (Class II for FDA regulations) (IEC / JIS standards conforming type: IEC / JIS, FDA regulations conforming type: FDA / IEC / JIS) (Max. output: 1 mW, Peak emission wavelength: 658 nm 0.026 mil)	
Beam diameter (Note 5)		400 \times 200 μ m 15.748 \times 7.874 mil approx.	100 \times 140 μ m 3.937 \times 5.512 mil approx.	70 \times 120 μ m 2.756 \times 4.724 mil approx.
Receiving element		Linear image sensor		
Enclosure earthing		Floating		
Material		Enclosure: Die-cast aluminum, Case cover: Die-cast aluminum, Front cover: Glass		
Cable		Cabtyre cable, 0.5 m 1.640 ft long with connector		
Cable extension		Extension up to total 30 m 98.425 ft is possible, with optional cable.		
Weight		Net weight: 300 g approx.		
Accessory		English warning label: 1 set [The FDA regulations conforming type includes a set of both the IEC label (written in English) and JIS label (written in Japanese)].		

- Notes: 1) Where measurement conditions have not been specified precisely, the conditions used were as follows: supply voltage 24 V DC, ambient temperature +20 $^{\circ}$ C **+68 $^{\circ}$ F**, sampling rate 100 μ s, average number of samples: 256 (**HL-C135C-BK10**: 512), object measured at measurement center distance is made of white ceramic (an aluminum vapor deposition surface reflection mirror was used with specular reflective type). Linearity also depends upon the characteristics of the object being measured.
- 2) These values were obtained by converting P-P values into a distance. The P-P values indicate the distribution of measured values throughout the measurement center distance.
- 3) These values were obtained with an average number of samples: 256 (**HL-C135C-BK10**: 512), when using an object made of our company's standard white ceramic for measurement (an aluminum vapor deposition surface reflection mirror was used with specular reflective types).
- 4) This value indicates the range of errors for an ideal linear displacement output, when using an object made of our company's standard white ceramic for measurement (an aluminum vapor deposition surface reflection mirror was used with specular reflective types). This value may fluctuate depending on the characteristics of the object measured.
- 5) These values were defined by using $1/e^2$ (13.5 %) of the center light intensity. If there is a slight leakage of light outside the normal spot diameter and if the periphery surrounding the sensing point has a higher reflectivity than the sensing point itself, then the results may be affected.

SPECIFICATIONS

Sensor heads

Item	Model No.	Type IEC / JIS standards conforming type FDA regulations conforming type	Specular reflective type	
			General purpose	High precision
			HL-C108B	HL-C105B
			HL-C108F	HL-C105F
Measurement center distance			81.4 mm 3.205 in	46 mm 1.811 in
Measuring range			±16 mm ±0.630 in	±4 mm ±0.157 in
Resolution (Note 2, 3)			2 μm 0.079 mil	1 μm 0.039 mil
Linearity (Note 4)			±0.1 % F.S.	
Temperature characteristics			0.02 % F.S./°C	
Laser emission indicator			Green LED (lights up during laser emission or immediately before laser emission)	
Measuring range indicator			Yellow LED (blinks within the measuring range and lights up when near the measurement center distance)	
Environmental resistance	Pollution degree		3 (Industrial environment)	
	Protection		IP67 (IEC) (excluding the connector)	
	Ambient temperature		0 to +45 °C +32 to +113 °F (No dew condensation), Storage: -20 to +70 °C -4 to +158 °F	
	Ambient humidity		35 to 85 % RH, Storage: 35 to 85 % RH	
	Ambient illuminance		Incandescent light: 3,000 lx at the light-receiving face	
	Voltage withstandability		500 V AC for one min. between the exclusive controller power input part and the sensor head enclosure	
	Insulation resistance		20 MΩ, or more, with 500 V DC megger between the exclusive controller power input part and the sensor head enclosure	
	Vibration resistance		10 to 55 Hz (period: 1 min.) frequency, 1.5 mm 0.059 in amplitude in X,Y and Z directions for two hours each	
	Shock resistance		196 m/s ² acceleration (20 G approx.) in X,Y and Z directions for three times each	
Emitting element			Red semiconductor laser, Class 2 (Class II for FDA regulations) (IEC / JIS standards conforming type: IEC / JIS, FDA regulations conforming type: FDA / IEC / JIS) (Max. output: 1 mW, Peak emission wavelength: 658 nm 0.026 mil)	
Beam diameter (Note 5)			100 × 140 μm 3.937 × 5.512 mil approx.	70 × 120 μm 2.756 × 4.724 mil approx.
Receiving element			Linear image sensor	
Enclosure earthing			Floating	
Material			Enclosure: Die-cast aluminum, Case cover: Die-cast aluminum, Front cover: Glass	
Cable			Cabtyre cable, 0.5 m 1.640 ft long with connector	
Cable extension			Extension up to total 30 m 98.425 ft is possible, with optional cable.	
Weight			Net weight: 300 g approx.	
Accessory			English warning label: 1 set [The FDA regulations conforming type includes a set of both the IEC label (written in English) and JIS label (written in Japanese)].	

- Notes: 1) Where measurement conditions have not been specified precisely, the conditions used were as follows: supply voltage 24 V DC, ambient temperature +20 °C **+68 °F**, sampling rate 100 μs, average number of samples: 256, object measured at measurement center distance is made of white ceramic (an aluminum vapor deposition surface reflection mirror was used with specular reflective type). Linearity also depends upon the characteristics of the object being measured.
- 2) These values were obtained by converting P-P values into a distance. The P-P values indicate the distribution of measured values throughout the measurement center distance.
- 3) These values were obtained with an average number of samples: 256, when using an object made of our company's standard white ceramic for measurement (an aluminum vapor deposition surface reflection mirror was used with specular reflective types).
- 4) This value indicates the range of errors for an ideal linear displacement output, when using an object made of our company's standard white ceramic for measurement (an aluminum vapor deposition surface reflection mirror was used with specular reflective types). This value may fluctuate depending on the characteristics of the object measured.
- 5) These values were defined by using 1/e² (13.5 %) of the center light intensity. If there is a slight leakage of light outside the normal spot diameter and if the periphery surrounding the sensing point has a higher reflectivity than the sensing point itself, then the results may be affected.

SPECIFICATIONS

Controllers

		Type	Photo-MOS relay output	
			Standard	For HL-C135C-BK10
Item	Model No.	HL-C1C-M	HL-C1C-M-WL	
Connection sensor heads		Maximum 2 sensor heads		
Supply voltage		24 V DC $\pm 10\%$ including ripple 0.5 V (P-P)		
Current consumption		When 1 sensor is connected: 430 mA approx., When 2 sensors are connected: 550 mA approx.		
Sampling rate		Selectable from 100 μ s / 144 μ s / 200 μ s / 255 μ s / 332 μ s / 498 μ s / 1,000 μ s		
Temperature characteristics		$\pm 0.01\%$ F.S./ $^{\circ}$ C		
Analog output	Voltage	Output voltage: ± 5 V/F.S. [default setting when diffuse reflective mode is selected (Note 2)] Output range: -10.9 to $+10.9$ V Output current: Max. 2 mA, Output impedance: 50 Ω		
	Current (Note 3)	Output current: 4 to 20 mA/F.S. [default setting when diffuse reflective mode is selected (Note 4)] Output range: 0 to 29.5 mA (maximum of 25 mA at max. load impedance) Load impedance: 250 Ω or less		
Alarm output		Photo-MOS relay • Maximum load current: 50 mA • Applied voltage: 30 V DC or less (between alarm output and COM) • ON impedance: 35 Ω or less • Operation time: Max. 2 ms		
	Output operation	Opened when the amount of light is excessive or insufficient.		
	Short-circuit protection	Incorporated		
Judgment outputs (O1, O2)		Photo-MOS relay • Maximum load current: 50 mA • Applied voltage: 30 V DC or less (between judgment output and COM) • ON impedance: 35 Ω or less • Operation time: Max. 2 ms		
	Utilization category	DC-12 or DC-13		
	Output operation	Opened or closed when the threshold value is reached. Determined based on judgment output mode selection. (The threshold value varies with the hysteresis setting.)		
	Short-circuit protection	Incorporated		
Serial input / output		RS-232C		
Timing input (Laser emission)		Laser emission stops or continues when voltage (using input voltage: 12 to 24 V DC, maximum input voltage: 30 V DC) is input or there is an open circuit: determined based on input mode selection.	_____	
Remote interlock input		_____	Laser emission stops when open circuit	
Zero set ON input		Zero set: ON when voltage (using input voltage: 12 to 24 V DC, maximum input voltage: 30 V DC) is input		
Zero set OFF input		Zero set: OFF when voltage (using input voltage: 12 to 24 V DC, maximum input voltage: 30 V DC) is input		
Indicators	Laser emission	Green LED (lights up during laser emission from sensor head 1 or sensor head 2, or immediately before laser emission)		
	BRIGHT	Red LED (lights up upon disabled measurement due to excessive light at sensor head 1 or 2)		
	DARK	Red LED (lights up upon disabled measurement due to insufficient light at sensor head 1 or 2)		
Setting / Data display		Compact console (optional)		
Calibration (Note 5)	Shift	± 20.0000 mm ± 0.787 in	± 200.0000 mm ± 7.874 in	
	Span	0.9000 to 1.1000		
Average number of samples (Note 5)		OFF, 2 to 32,768 times (16 steps)		
Digital filters (Note 5)		High pass: OFF, 10 to 2,000 Hz (9 steps), Low pass: OFF, 10 to 2,000 Hz (9 steps)		
Calculation functions (Note 5)		L \pm KA, L \pm KB, L \pm K (A \pm B) A, B: Sensor head 1, Sensor head 2 measurement values, L = ± 999.9999 , K = 0.0001 to 99.9999		
Hold functions (Note 5)		Selectable from NORMAL / P-P / PEAK / VALLEY		
Environmental resistance	Pollution degree	3 (Industrial environment)		
	Ambient temperature	0 to $+50$ $^{\circ}$ C $+32$ to $+122$ $^{\circ}$ F (No dew condensation), Storage: -20 to $+70$ $^{\circ}$ C -4 to $+158$ $^{\circ}$ F		
	Ambient humidity	35 to 85 % RH, Storage: 35 to 85 % RH		
	Voltage withstandability	500 V AC for one min. between power input part and enclosure		
	Insulation resistance	20 M Ω , or more, with 500 V DC megger between power input part and enclosure		
	Vibration resistance	10 to 55 Hz frequency (period: 1 min.) 0.75 mm 0.030 in amplitude in X,Y and Z directions for 30 min. each		
	Shock resistance	196 m/s ² (20 G approx.) in X, Y and Z directions for 3 times each		
Cable length		Power line: Less than 10 m 32.808 ft, Signal line: Less than 30 m 98.425 ft		
Weight		Net weight: 300 g approx.		
Accessory		_____	Key: 2 pcs.	

Notes: 1) Where measurement conditions have not been specified precisely, the conditions used were as follows: supply voltage 24 V DC, ambient temperature $+20$ $^{\circ}$ C $+68$ $^{\circ}$ F, sampling rate 100 μ s, average number of samples: 256 (HL-C1C-M-WL: 512), and measurement center distance.

2) If specular reflective mode is selected, then the default setting is ± 4 V/F.S.

3) The maximum analog output current will vary with load impedance.

4) If specular reflective mode is selected, then the default setting is 5.6 to 18.4 mA/F.S.

5) These values can be set using the command input from external equipment via the compact console and RS-232C interface.

SPECIFICATIONS

Compact consoles

Item	Type	Standard	For HL-C1C-M-WL
	Model No.	HL-C1DP1-E	HL-C1DP1-E-WL
Supply voltage	24 V DC $\pm 10\%$ including ripple 0.5 V (P-P)		
Current consumption	200 mA or less		
Display	Display element	STN monochrome LCD	
	Back light	White LED	
	Display range	-999.9999 to 999.9999	
	Language	English	
Touch panel	Operation force	0.5 N or less	
	Lifetime	1,000,000 times or more (Note 1)	
Environmental resistance	Environment resistance	IP65 (at initial status) (Note 2) Dust prevention and drip-proof at the front panel (waterproof packing is used at the contact surface to board)	
	Ambient temperature	0 to +50 °C +32 to +122 °F (No dew condensation or icing allowed), Storage: -20 to +60 °C -4 to +140 °F	
	Ambient humidity	20 to 85 % RH, Storage: 10 to 85 % RH	
	Electrostatic noise resistance	5,000 V or more (panel surface)	
	Vibration resistance	10 to 55 Hz frequency, 0.75 mm 0.030 in amplitude in X, Y, and Z directions for 10 min. each	
	Shock resistance	98 m/s ² or more acceleration (10G approx.) in X, Y, and Z directions for four times each	
Material	Case: PPE, Front protective sheet: Polyester		
Weight	230 g approx.		
Accessory	Connection cable for connecting the controller to the console: 1 pc., Mounting bracket: 1 set		

Notes: 1) This value indicates the average lifetime of the unit when used under a normal temperature of +25 °C **+77 °F**.

2) When reinstalling the console, replace the water proof packing. (Matsushita Electric Works, Ltd., Part No: AIGT181, 10 packs included)

I/O CIRCUIT AND WIRING DIAGRAMS

HL-C1C-M(-WL) Controller

Input circuit diagram

Connection example 1 (NPN)

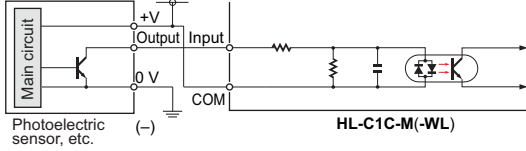

Connection example 2 (PNP)

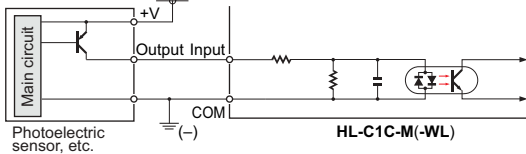

Output circuit diagram

Alarm output, Judgment output

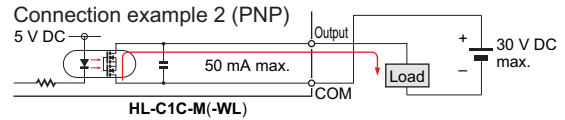
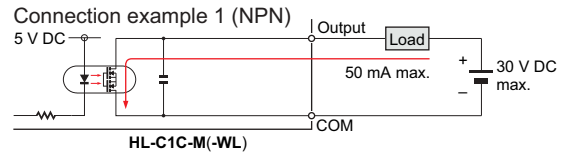

Analog output diagram

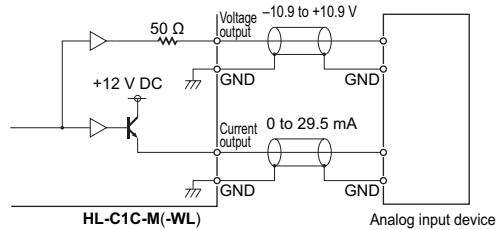

Notes: 1) Do not short-circuit analog output terminals or apply voltage to them.
2) Use shielded wires for analog outputs.

Terminal arrangement

Input terminals

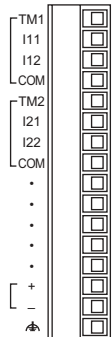

Symbol	Description
TM1 (Note 1)	Timing input (sensor head 1) (Note 1)
I11	Zero set ON input (sensor head 1)
I12	Zero set OFF input (sensor head 1)
COM	Input common
TM2 (Note 2)	Timing input (sensor head 2) (Note 2)
I21	Zero set ON input (sensor head 2)
I22	Zero set OFF input (sensor head 2)
COM	Input common
•	Not used
•	Not used
•	Not used
•	Not used
•	Not used
+	24 V DC input for power supply
-	Power supply ground
⏏	Function ground

Output terminals

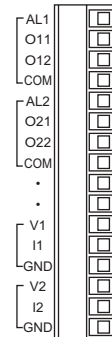

Symbol	Description
AL1	Alarm output (sensor head 1)
O11	Judgment output 1 (sensor head 1)
O12	Judgment output 2 (sensor head 1)
COM	Output common
AL2	Alarm output (sensor head 2)
O21	Judgment output 1 (sensor head 2)
O22	Judgment output 2 (sensor head 2)
COM	Output common
•	Not used
•	Not used
V1	Analog voltage output (sensor head 1)
I1	Analog current output (sensor head 1)
GND	Analog output ground
V2	Analog voltage output (sensor head 2)
I2	Analog current output (sensor head 2)
GND	Analog output ground

Notes: 1) In the case of HL-C1C-M-WL, "IL1: Remote interlock input (sensor head 1)"
2) In the case of HL-C1C-M-WL, "IL2: Remote interlock input (sensor head 2)"
3) Terminals marked with "*" are not used. Some are connected to internal circuitry and cannot be used as relay terminals in wiring, etc.

SENSING CHARACTERISTICS (TYPICAL)

HL-C135C-BK10 Diffuse reflective type

Correlation between measuring distance and error characteristics

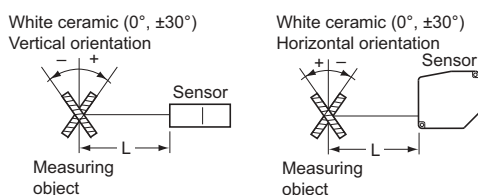

Vertical positioning

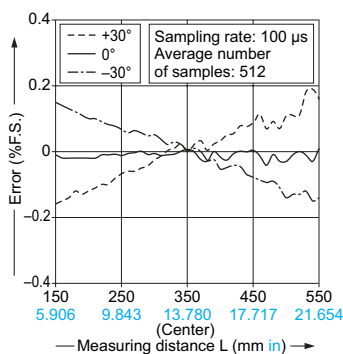

Horizontal positioning

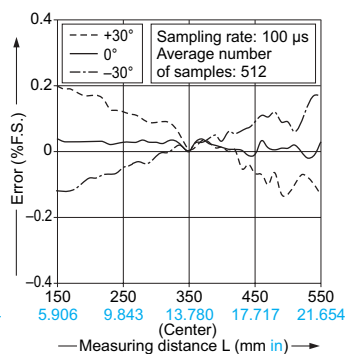

SENSING CHARACTERISTICS (TYPICAL)

HL-C108□-BK

Diffuse reflective type

Correlation between measuring distance and error characteristics

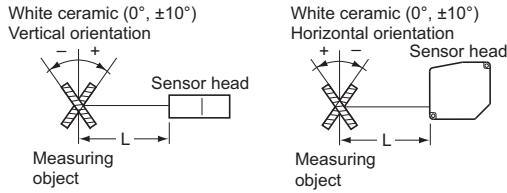

Vertical positioning

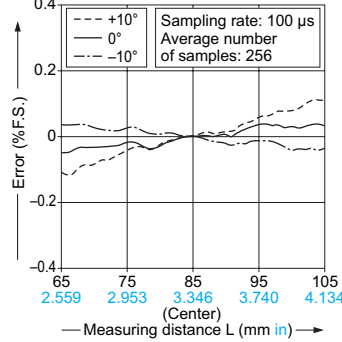

Horizontal positioning

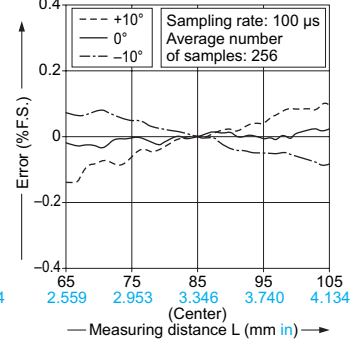

HL-C105□-BK

Diffuse reflective type

Correlation between measuring distance and error characteristics

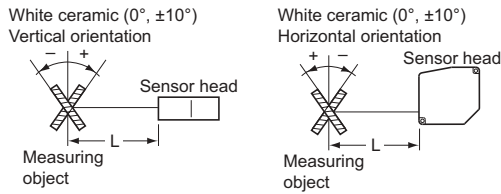

Vertical positioning

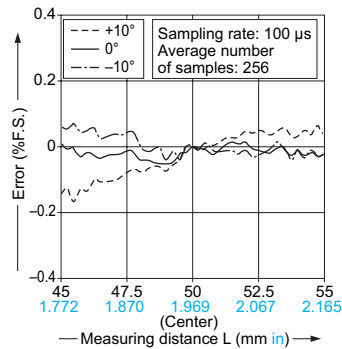

Horizontal positioning

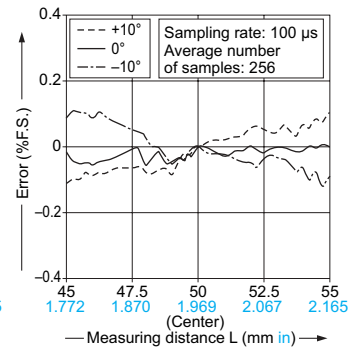

HL-C108B HL-C108F

Specular reflective type

Correlation between measuring distance and error characteristics

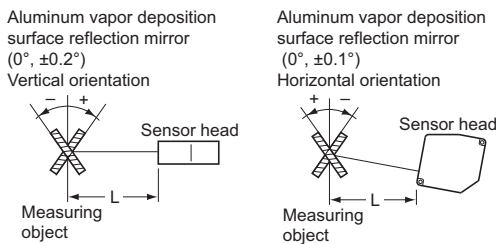

Vertical positioning

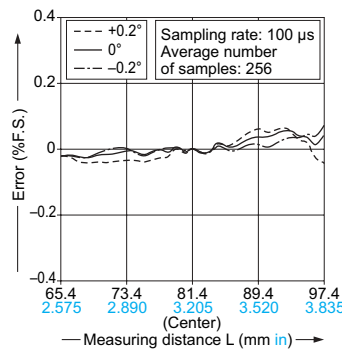

Horizontal positioning

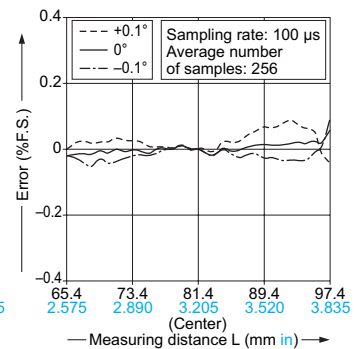

HL-C105B HL-C105F

Specular reflective type

Correlation between measuring distance and error characteristics

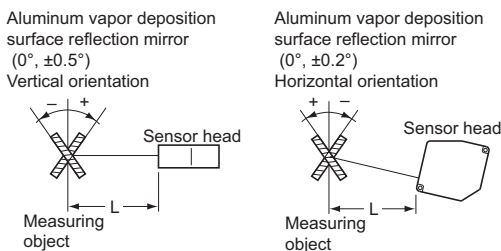

Vertical positioning

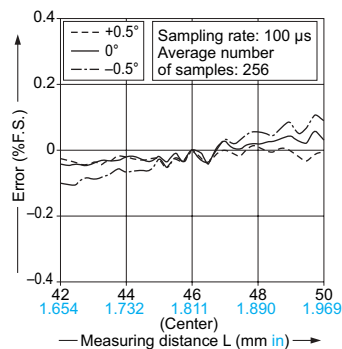

Horizontal positioning

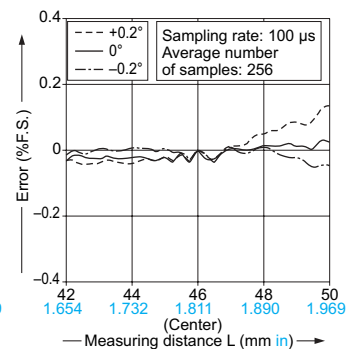

PRECAUTIONS FOR PROPER USE

• This catalog is a guide to select a suitable product. Be sure to read instruction manual attached to the product prior to its use.

⚠

- Never use this product as a sensing device for personnel protection.
- In case of using sensing devices for personnel protection, use products which meet laws and standards, such as OSHA, ANSI or IEC etc., for personnel protection applicable in each region or country.

HL-C108□
HL-C105□

- This product is classified as a Class 2 Laser Product in IEC / JIS standards and a Class II Laser Product in FDA regulations. Do not look at the laser beam directly or through optical system such as a lens.
- The following label is attached to the product. Handle the product according to the instruction given on the warning label.



(The English warning label based on FDA regulations is pasted on the FDA regulations conforming type.)

(The English warning label is packed with the sensor)

HL-C135C-BK10

- This product is classified as a Class 3B Laser Product in IEC / JIS standards Class IIIb. Never look at or touch the direct laser beam and its reflection.
- The following label is attached to the product. Handle the product according to the instruction given on the warning label.



(The English warning label based on FDA regulations is pasted on the FDA regulations conforming type.)

(The English warning label is packed with the sensor)

To comply with the European EMC Directive (HL-C1C-M-WL)

• To comply with the European EMC Directive, install a ferrite core on wires to the terminal block as shown below.

Recommended ferrite core:
E04RC281613 manufactured by Seiwa Electric Mfg. Co., Ltd or equivalent

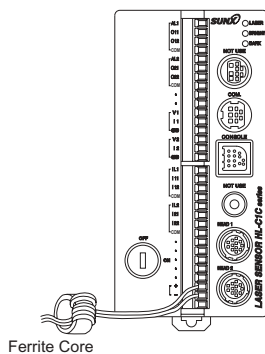

Sensor head mounting direction

• To obtain the greatest precision, the sensor head should be oriented facing the direction of movement of the object's surface, as shown in the figure below.

Rotating object

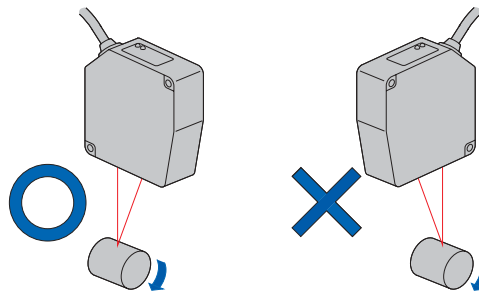

Object that has large differences in gaps, grooves and colors

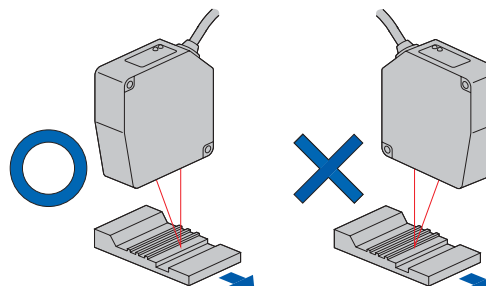

Safety standards for laser beam products

• A laser beam can harm human being's eyes, skin, etc., because of its high energy density. IEC and JIS have classified laser products according to the degree of hazard and the stipulated safety requirements.

HL-C108□ and **HL-C105□**: Classified as Class 2 laser products
HL-C135C-BK10: Classified as a Class 3B laser products

Classification by IEC 60825-1: 2001

Classification	Description
Class 1	Lasers that are safe under reasonably foreseeable conditions of operation, including the use of optical instruments for intrabeam viewing.
Class 1M	Lasers emitting in the wavelength range from 302.5 nm to 4,000 nm which are safe under reasonably foreseeable conditions of operation, but may be hazardous if the user employs optics within the beam.
Class 2	Lasers that emit visible radiation in the wavelength range from 400 nm to 700 nm where eye protection is normally afforded by aversion responses, including the blink reflex. This reaction may be expected to provide adequate protection under reasonably foreseeable conditions of operation including the use of optical instruments for intrabeam viewing.
Class 2M	Lasers that emit visible radiation in the wavelength range from 400 nm to 700 nm where eye protection is normally afforded by aversion responses, including the blink reflex. However, viewing of the output may be more hazardous if the user employs optics within the beam.
Class 3R	Lasers that emit in the wavelength range from 302.5 nm to 10 ⁶ nm where direct intrabeam viewing is potentially hazardous but the risk is lower than for Class 3B lasers, and fewer manufacturing requirements and control measures for the user apply than for Class 3B lasers.
Class 3B	Lasers that are normally hazardous when direct intrabeam exposure occurs (i.e. within the NOHD). Viewing diffuse reflections is normally safe.
Class 4	Lasers that are also capable of producing hazardous diffuse reflections. They may cause skin injuries and could also constitute a fire hazard.

PRECAUTIONS FOR PROPER USE

Safe use of laser products

- For the purpose of preventing users from suffering injuries by laser products, IEC 60825-1: 2001 (JIS C 6802: 2005) (Safety of laser products). Kindly check the standards before use.

Summary of user precautions IEC 60825-1: 2001 (JIS C 6802: 2005)

* Quoted from Safety of laser products, Annex Table D. 3

Requirements subclause	Classification						
	Class 1	Class 1M	Class 2	Class 2M	Class 3R	Class 3B	Class 4
Laser safety officer	Not required but recommended for applications that involve direct viewing of the laser beam				Not required for visible emission Required for non-visible emission	Required	
Remote interlock	Not required				Connect to room or door circuits		
Key control	Not required				Remove key when not in use		
Beam attenuator	Not required				When in use prevents inadvertent exposure		
Emission indicator device	Not required				Indicates laser is energized for non-visible wavelengths	Indicates laser is energized	
Warning signs	Not required				Follow precautions on warning signs		
Beam path	Not required	Class 1M (Note 1) as for Class 3B	Not required	Class 2M (Note 2) as for Class 3B	Terminate beam at end of useful length		
Specular reflection	No requirements	Class 1M (Note 1) as for Class 3B	No requirements	Class 2M (Note 2) as for Class 3B	Prevent unintentional reflections		
Eye protection	No requirements				Required if engineering and administrative procedures not practicable and MPE exceeded		
Protective clothing	No requirements				Sometimes required	Specific requirements	
Training	No requirements	Class 1M (Note 1) as for Class 3R	No requirements	Class 2M (Note 2) as for Class 3R	Required for all operator and maintenance personnel		

- Notes: 1) Class 1M laser products that failed condition 1 of table 10. Not required for Class 1M laser products that failed condition 2 of table 10.
2) Class 2M laser products that failed condition 1 of table 10. Not required for Class 2M laser products that failed condition 2 of table 10.

Remarks: This table is intended to provide a convenient summary of precautions. See text of this standard for complete precautions.

Mutual interference

- When installing 2 or more sensor heads side by side, mutual interference will not occur if the laser spots from other sensor heads do not fall within the shaded areas of the sensor head in the figure below. Multiple sensor heads must be installed in a manner such that laser spots from other sensor heads will be prevented from falling within these shaded areas. When two sensor heads are connected to a controller and used, the measures described below are not required since the mutual interference prevention function can be used.

HL-C108□

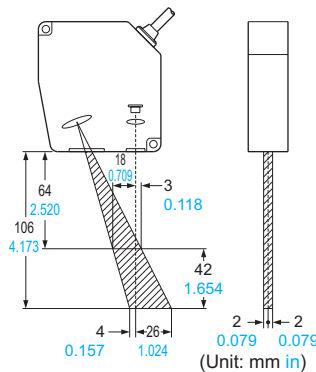

HL-C105□

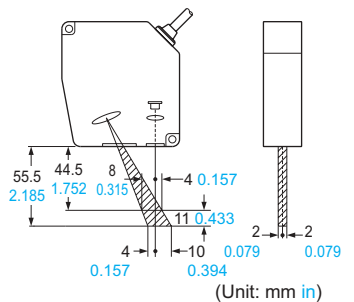

HL-C135C-BK10

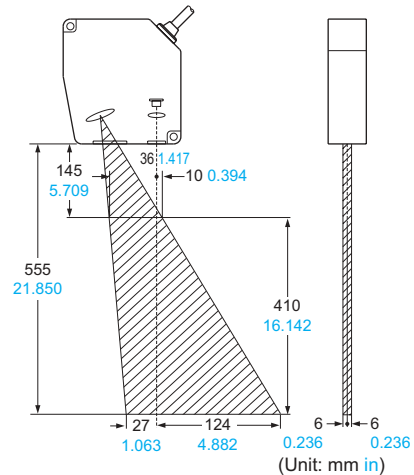

Functional description

Sensor head

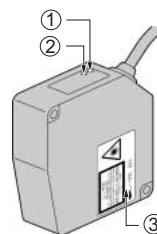

	Description	Function
①	Laser emission indicator (Green LED)	Lights up during laser emission or immediately before laser emission.
②	Measuring range indicator (Yellow LED)	Blinks within the measuring range and lights up when near the measurement center distance.
③	Warning label	Shows the laser emission position.

PRECAUTIONS FOR PROPER USE

Functional description

Controller

<HL-C1C-M>

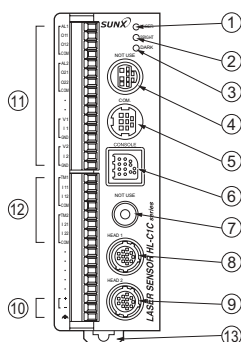

<HL-C1C-M-WL>

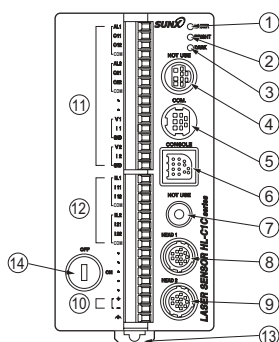

Description	Function
① Laser emission indicator (Green LED)	Lights up during laser emission from sensor head 1 or sensor head 2, or immediately before laser emission.
② BRIGHT indicator (Red LED)	Lights up upon disabled measurement due to excessive light at sensor head 1 or 2.
③ DARK indicator (Red LED)	Lights up upon disabled measurement due to insufficient light at sensor head 1 or 2.
④	Cannot be used. This port is for adjustment at the factory before shipping.
⑤ COM. port	Used for RS-232C communications with a personal computer.
⑥ Connector for compact console	This enables measurement values to be displayed using the compact console and connection of the compact console exclusive connection cable when setting each setting.
⑦	Cannot be used. This port is for adjustment at the factory before shipping.
⑧ Sensor head 1 connector	The controller operates the sensor head connected to this connector as sensor head 1.
⑨ Sensor head 2 connector	The controller operates the sensor head connected to this connector as sensor head 2.
⑩ Power supply terminal	Supplies 24 V DC. There are power supply terminals on input terminal block.
⑪ External output terminal	
⑫ External input terminal	
⑬ DIN rail mounting hook	Can be mounted on a 35 mm 1.378 in width DIN rail quickly.
⑭ Key switch	Turning on the key switch starts up the controller. Please take out the key when it is not being used.

Functions

Function	Details
Data buffering function	<ul style="list-style-type: none"> It is possible to accumulate data up to 48,000 data into a controller temporarily in order to capture measurement data into a PC. All the accumulated data can be captured into the PC with HL-C1AiM. Used for reading and storing all data including the verification of measurement data when introduced as well as all post-measurement data.
Hold function	<ul style="list-style-type: none"> NORM. (no hold): Outputs the amount of displacement from the measurement center distance in real time. Ordinarily, this mode is used. P-P: This mode holds and outputs the difference between the maximum value and the minimum value. It is used for vibration measurements or eccentricity. PEAK: Holds and outputs the maximum measurement value. VALLEY: Holds and outputs the minimum measurement value.

Function	Details
Zero set function	<ul style="list-style-type: none"> The measurement value and analog output at the timing of zero setting are forcibly reset to zero. Use this function to reset the measurement value of the reference object to zero and measure the displacement amount or make a judgment of the upper or lower limit.
Timing function (excluding HL-C1C-M-WL)	<ul style="list-style-type: none"> The judgment outputs (O1 and O2) immediately before the mode selection, measurement value and analog output are held in the timing input mode. Laser emission can be halted or continued according to a setting. Add the input in other than the measurement or judgment state to eliminate unnecessary output changes or laser radiation.
Remote interlock function [HL-C1C-M-WL only]	<ul style="list-style-type: none"> This function stops laser radiation. Turning on the remote interlock input maintains the judgment output and then either holds values measurement values or analog outputs to the values just obtained or outputs the fixed values.
Display hold function	<ul style="list-style-type: none"> Only the measurement value displayed on the compact console is held. Use this function to read a momentary measurement value.
Switching functions for sampling rate	<ul style="list-style-type: none"> In cases where objects with a low reflected light amount, such as black rubber, are measured, stable measurements can be taken by extending the sampling rate and enabling a sufficient amount of light to be picked up by the sensor. If the sampling rate is short and not enough light can be picked up, the sensor enters the alarm state, so switch the sampling rate to a longer duration setting. The sampling rate can be switched among 7 different rates. (100 μs / 144 μs / 200 μs / 255 μs / 332 μs / 498 μs / 1,000 μs)
Calculation function	<p>This function enables the unit to perform the following calculations:</p> <p><Calculation formulas when performing independent measurements> L1 + K1A: normal output state L2 + K2B: normal output state L1 - K1A: reverses the polarity of the measured value L2 - K2B: reverses the polarity of the measured value</p> <p><Calculation formulas when performing calculation measurements> L + K (A + B): addition L - K (A + B): used when measuring thickness L + K (A - B): subtraction, used when measuring level differences L - K (A - B): used when reversing the polarity of a subtraction output A: the value measured by sensor head 1 B: the value measured by sensor head 2 L: the amount of offset for the measured value K: the coefficient used to adjust the ratio of displacement changes</p>
Switching functions for measurement mode	<ul style="list-style-type: none"> The measurement mode (diffuse reflective / specular reflective) can be switched between these two modes, in accordance with the sensor head selected, based on the measurement object. Diffuse reflective mode: used when measuring a substance without a mirror surface or not transparent. Specular reflective mode: used when measuring a substance with a mirror surface or is transparent. <p>When in specular reflective mode, the measurement object can be selected from the following options: Standard: used when measuring the mirror surface of opaque substance such as metal, etc. Front: used when measuring the surface of transparent substance such as glass, etc. Rear: used when measuring the rear surface of transparent substance such as glass, etc.</p> <p>The measurement center distance is shifted. Thickness: used when measuring the thickness of transparent substance such as glass.</p> <div style="border: 1px solid black; padding: 5px; margin-top: 10px;"> <p>The refraction angle is compensated to 1.55. There is a limitation in measurable thickness.</p> <p>Thickness measurement guidelines for common glass sheets: General-purpose model – thicknesses 1.2 mm 0.047 in or more High precision model – thicknesses 0.5 mm 0.020 in or more</p> </div>
Low-pass filter function	<ul style="list-style-type: none"> For example, if the surface conditions of a metal object cause noise that interferes with accurate measurement, the use of the low-pass filter function will reduce the effects of noise and allow for the stable measurement of displacement. 9 independent cutoff frequencies can be selected, OFF or ranging from 10 to 2,000 Hz.

PRECAUTIONS FOR PROPER USE

Functions

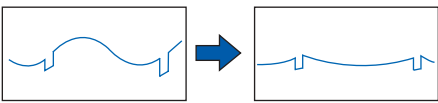
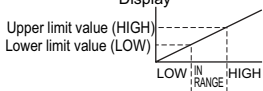
Function	Details																																																		
High-pass filter function	<ul style="list-style-type: none"> If joints or grooves are being measured in the midst of great changes such as runout or inclination in an eccentric rotating object etc., this setting minimizes the effects of gradual changes and makes it possible to detect joints or grooves. 9 independent cutoff frequencies can be selected, OFF or ranging from 10 to 2,000 Hz. 																																																		
Switching function for average number of samples	<ul style="list-style-type: none"> If the measured values are subject to rapid fluctuation, then increasing the average number of samples will allow the unit to compensate for these fluctuations, enabling stable measurements to be obtained. The average number of samples can be selected from among 16 steps, ranging from OFF to 32,768 times. 																																																		
Judgment output selection function	<ul style="list-style-type: none"> The judgment output O1, O2 (NC) can be selected from the four types listed in the table below. <div style="display: flex; align-items: flex-start;"> <div style="margin-right: 20px;"> <p>Display</p>  <p>Upper limit value (HIGH) Lower limit value (LOW)</p> <p>LOW IN RANGE HIGH Displacement (+)</p> </div> <table border="1" style="font-size: small;"> <caption>Logical output and judgment</caption> <thead> <tr> <th>Output</th> <th>Judgment</th> <th>LOW</th> <th>IN RANGE</th> <th>HIGH</th> </tr> </thead> <tbody> <tr> <td>O1</td> <td></td> <td>1</td> <td>0</td> <td>1</td> </tr> <tr> <td>O2</td> <td></td> <td>0</td> <td>1</td> <td>1</td> </tr> </tbody> </table> <p>(+) 1: Output state</p> </div> <table border="1" style="width: 100%; font-size: x-small;"> <thead> <tr> <th>O1</th> <th>O2</th> <th>Open</th> <th>Close</th> <th>Open</th> <th>Close</th> <th>Description</th> </tr> </thead> <tbody> <tr> <td>LOW</td> <td>LOW</td> <td></td> <td></td> <td></td> <td></td> <td>Select to distinguish the side of the measurement value around the lower limit value setting. The upper limit setting is ignored.</td> </tr> <tr> <td>LOW</td> <td>HIGH</td> <td></td> <td></td> <td></td> <td></td> <td>Select to distinguish between the upper limit and lower limit when the measurement value exceeds either limit.</td> </tr> <tr> <td>LOW or HIGH</td> <td>IN RANGE</td> <td></td> <td></td> <td></td> <td></td> <td>Select to distinguish between deviation from the upper or lower limit value and containment in the range. Use this for OK / NG judgment.</td> </tr> <tr> <td>LOGIC</td> <td>LOGIC</td> <td></td> <td></td> <td></td> <td></td> <td>Select to distinguish whether the measurement value is below the lower limit value, above the upper limit value or within the range. Build an external logical circuit to judge two outputs and separate them into three states.</td> </tr> </tbody> </table> <p> : Output state (excluding hysteresis area) * The output state is the state in which the terminal is open. (NC)</p>	Output	Judgment	LOW	IN RANGE	HIGH	O1		1	0	1	O2		0	1	1	O1	O2	Open	Close	Open	Close	Description	LOW	LOW					Select to distinguish the side of the measurement value around the lower limit value setting. The upper limit setting is ignored.	LOW	HIGH					Select to distinguish between the upper limit and lower limit when the measurement value exceeds either limit.	LOW or HIGH	IN RANGE					Select to distinguish between deviation from the upper or lower limit value and containment in the range. Use this for OK / NG judgment.	LOGIC	LOGIC					Select to distinguish whether the measurement value is below the lower limit value, above the upper limit value or within the range. Build an external logical circuit to judge two outputs and separate them into three states.
Output	Judgment	LOW	IN RANGE	HIGH																																															
O1		1	0	1																																															
O2		0	1	1																																															
O1	O2	Open	Close	Open	Close	Description																																													
LOW	LOW					Select to distinguish the side of the measurement value around the lower limit value setting. The upper limit setting is ignored.																																													
LOW	HIGH					Select to distinguish between the upper limit and lower limit when the measurement value exceeds either limit.																																													
LOW or HIGH	IN RANGE					Select to distinguish between deviation from the upper or lower limit value and containment in the range. Use this for OK / NG judgment.																																													
LOGIC	LOGIC					Select to distinguish whether the measurement value is below the lower limit value, above the upper limit value or within the range. Build an external logical circuit to judge two outputs and separate them into three states.																																													

Function	Details
Hysteresis setting function	<ul style="list-style-type: none"> Optional hysteresis settings can be selected for both the upper and lower limits.
Analog output setting function	<ul style="list-style-type: none"> This function causes the output to correspond to the measurement value wanted at an analog output of +5 V (20 mA) and at -5 V (4 mA). It can be used for scaling of the analog output or for making the output greater or smaller, etc. When this function is used, the analog output corresponding to measurement values ranging between, for example, 70 to 90 mm 2.756 to 3.543 in, can be assigned to outputs ranging from -5 V (for 70 mm 2.756 in) to +5 V (for 90 mm 3.543 in).
Analog output switching function during alarm	<ul style="list-style-type: none"> You can switch between the data having been output immediately before and a fixed value as an analog output issued when measurement is disabled (with an alarm output) due to an excessive or insufficient amount of light or deviation from the range. When the fixed value setting is selected, either the maximum value (voltage output: +10.9 V, current output: 29.5 mA) or minimum value (voltage output: -10.9 V, current output: 0 mA) of the analog output is issued during an alarm.
Input selection function	<ul style="list-style-type: none"> The timing signal at the input terminal functions as an input upon a short circuit by default setting. Use this function to activate the input upon an open circuit.
Calibration function	<ul style="list-style-type: none"> Measurement errors may occur due to the color, material or surface condition of the object being measured. These differences can be compensated for through calibration. The calibration function allows the span and shift to be set for each sensor head. There are two ways to set these values. One is to conduct auto setting by moving a piece of the object past sensors and the other is to input previously measured values directly.
Display light received function	<ul style="list-style-type: none"> This function displays the peak level of light received at the measuring point. The usage of this function when installing sensor heads allows the optimum marginal increment to be used as the level of light received for measurement.
Save function	<ul style="list-style-type: none"> This function saves all setting data except for the timing input state and display hold state.

HL-C108□-BK

Sensor head

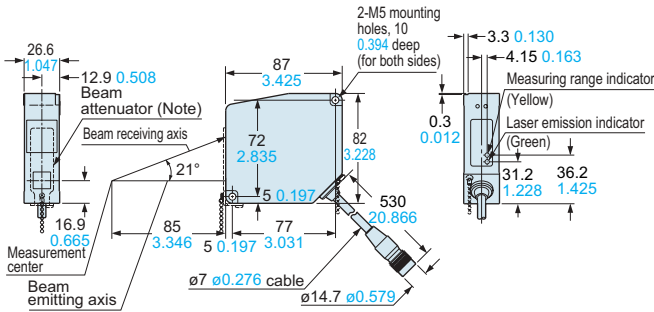

Note: There is not beam attenuator on IEC / JIS standards conforming type.

HL-C108B HL-C108F

Sensor head

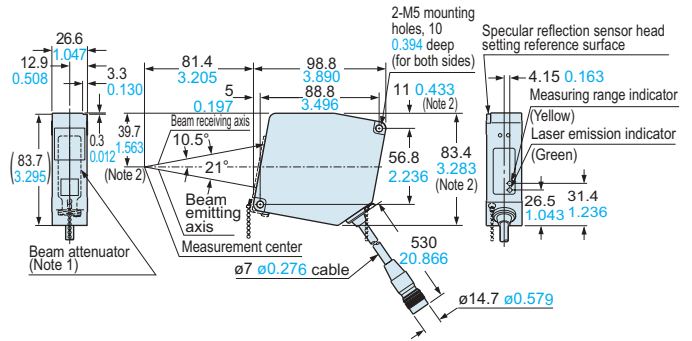

Notes: 1) There is not beam attenuator on IEC / JIS standards conforming type.
2) Figure shows standard installation level dimensions.

HL-C105□-BK

Sensor head

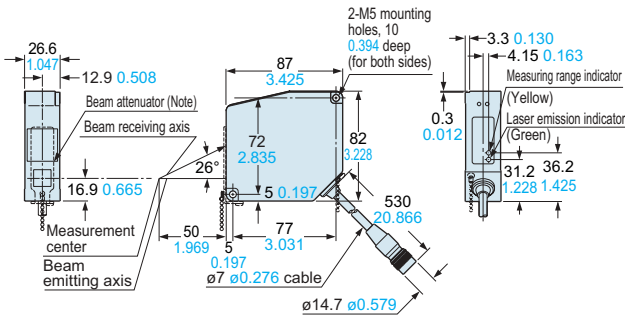

Note: There is not beam attenuator on IEC / JIS standards conforming type.

HL-C105B HL-C105F

Sensor head

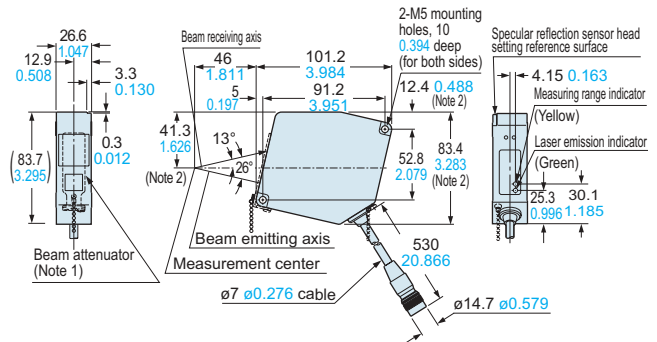

Notes: 1) There is not beam attenuator on IEC / JIS standards conforming type.
2) Figure shows standard installation level dimensions.

HL-C135C-BK10

Sensor head

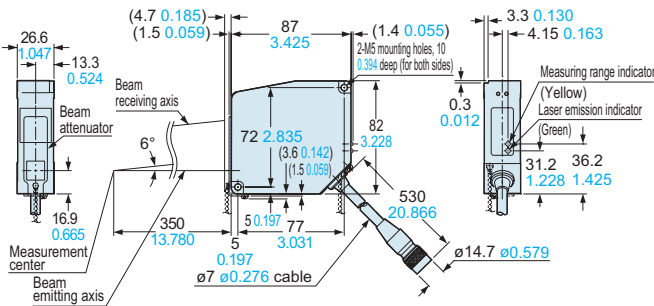

HL-C1C-M

Controller

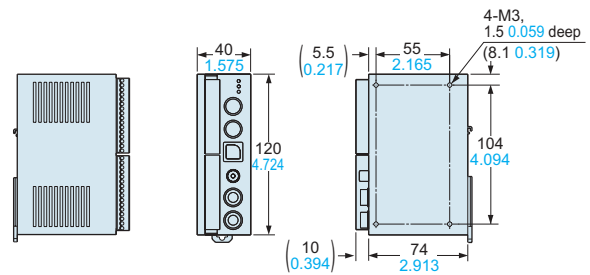

DIMENSIONS (Unit: mm in)

The CAD data in the dimensions can be downloaded from the SUNX website: <http://www.sunx.com>

HL-C1C-M-WL

Controller

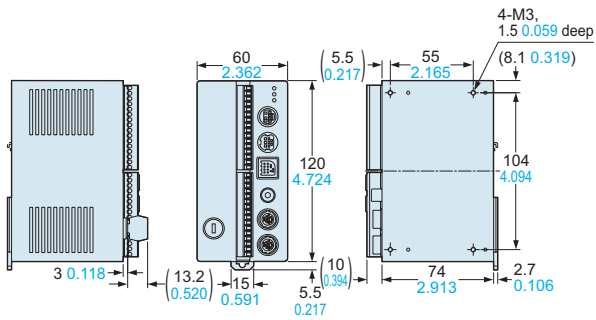

HL-C1DP1-E(-WL)

Compact console

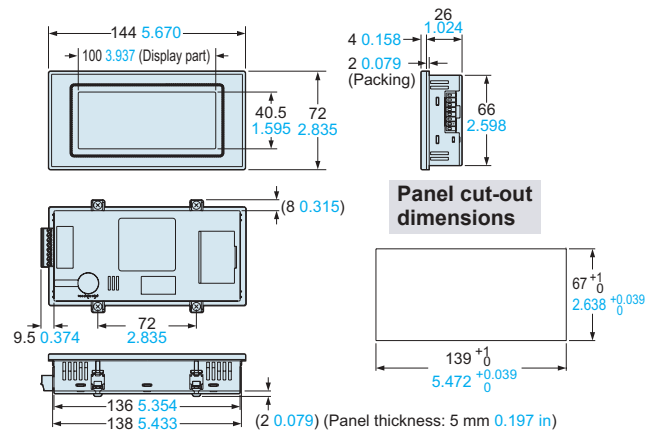

HL-C1CCJ□

Extension cable

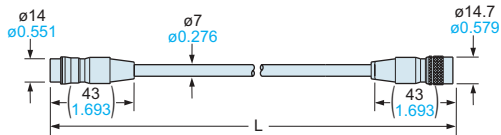

• Length L

Model No.	Length L (mm in)
HL-C1CCJ2	2,000 78.740
HL-C1CCJ5	5,000 196.850
HL-C1CCJ10	10,000 393.700
HL-C1CCJ20	20,000 787.400
HL-C1CCJ30	30,000 1181.100

All information is subject to change without prior notice.



<http://www.sunx.com>

SUNX Limited

2431-1 Ushiyama-cho, Kasugai-shi, Aichi,
486-0901, Japan
Phone: +81-568-33-7211
FAX: +81-568-33-2631

Overseas Sales Division

Phone: +81-568-33-7861
FAX: +81-568-33-8591